



electrical installation systems

New!

FIBERGLASS BOARDS

TECHNICAL FEATURES

The distribution boards are characterized by the high performance of the material they are made of: polyester reinforced with fiberglass. This material doesn't change in a temperature range between $-40\text{ }^{\circ}\text{C}$ and $+110\text{ }^{\circ}\text{C}$, has a distortion temperature greater than $220\text{ }^{\circ}\text{C}$, and resists to chemical and atmospheric agents. They are particularly suitable for photovoltaic systems, for outdoor applications or aggressive industrial environments, for instance in the presence of salt.

The polyester reinforced with fiberglass is halogen free and self-extinguishing HB according to the Standard UL94. The boards are grey RAL 7035.

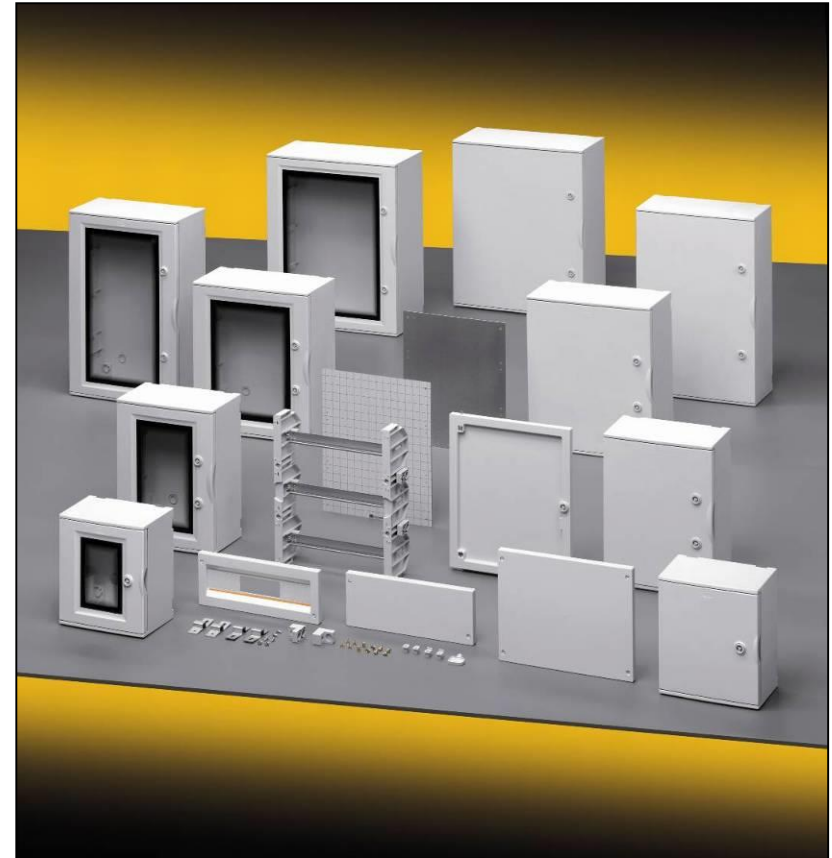

FIBERGLASS BOARDS

TECHNICAL FEATURES

The boards are available in 7 dimensions with blank door or transparent window.

The polyurethane foam continuous gaskets permit to keep IP65 protection degree and make the boards suitable for outdoor installations and for applications in wet environments.

The modular frames allow the assembly and the wiring of the devices outside the board, ensuring the maximum accessibility for all necessary operations.

The frames permit to install from 36 to 190 modules; they can be completed with blank or predrilled modular panels for DIN-devices, with adjustable DIN-rails and are suitable for the mounting of slotted trunkings to be placed behind the installed devices.



QUBE  *system*

FIBERGLASS BOARDS

TECHNICAL FEATURES

The counterdoors adjustable to two different heights, can be combined to the back plates to build control panels.

Metal or insulating back plates can be fixed to the bottom of the boards and be adjusted to different heights.

Possibility to install switches with standard heights of 48, 75 and 102 mm

Double insulation, class II

Shock resistance IK10

Installation and operating temperature from -25 °C to +60 °C

Resistance to abnormal heat (GWT)

960 °C with blank door



QUBE  *system*

FIXING OF THE BOARDS

Through direct fixing to the wall by preset positions with screw cover caps to keep IP-protection degree and double insulation.

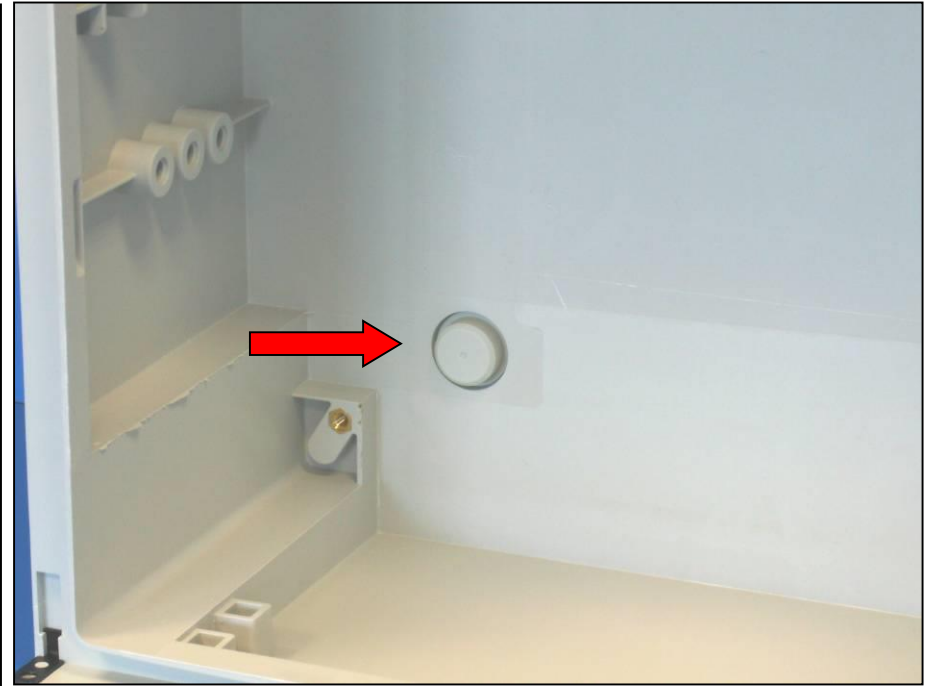
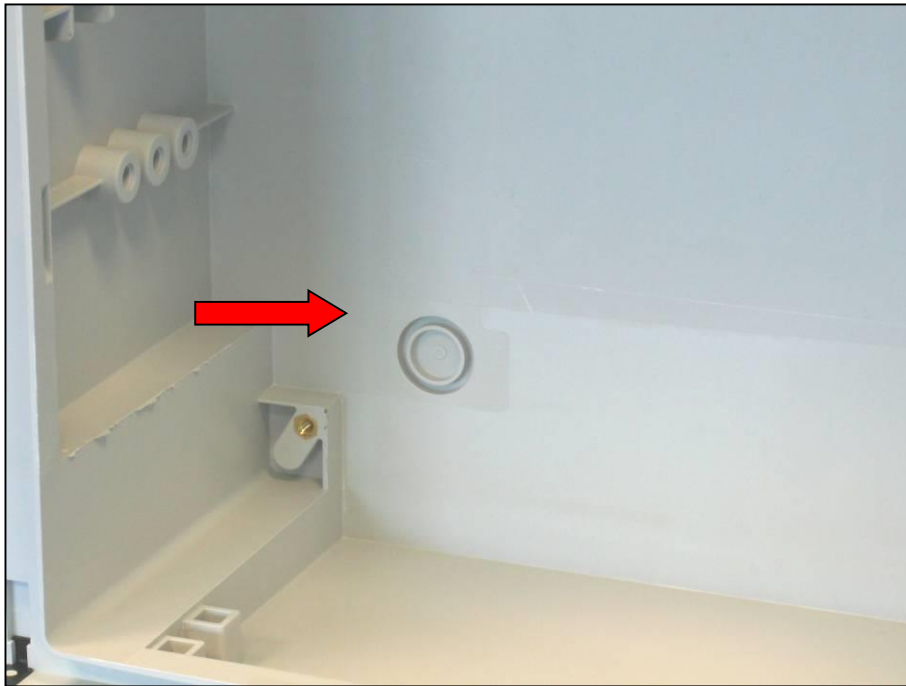

FIXING OF THE BOARDS

Through galvanized or stainless steel brackets, bolted to the proper fixed inserts, with the maintenance of IP-protection degree and double insulation

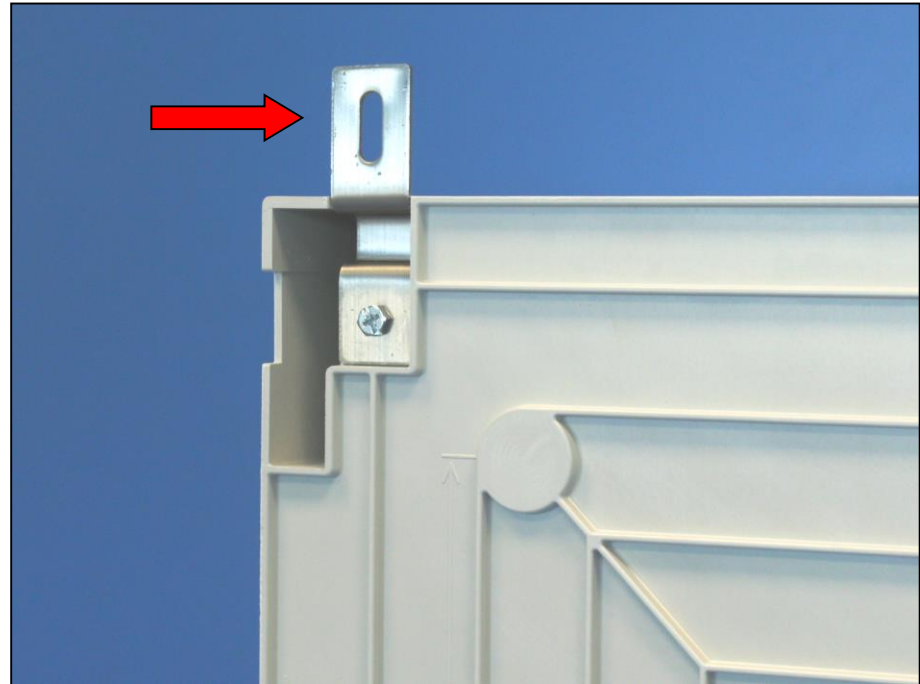
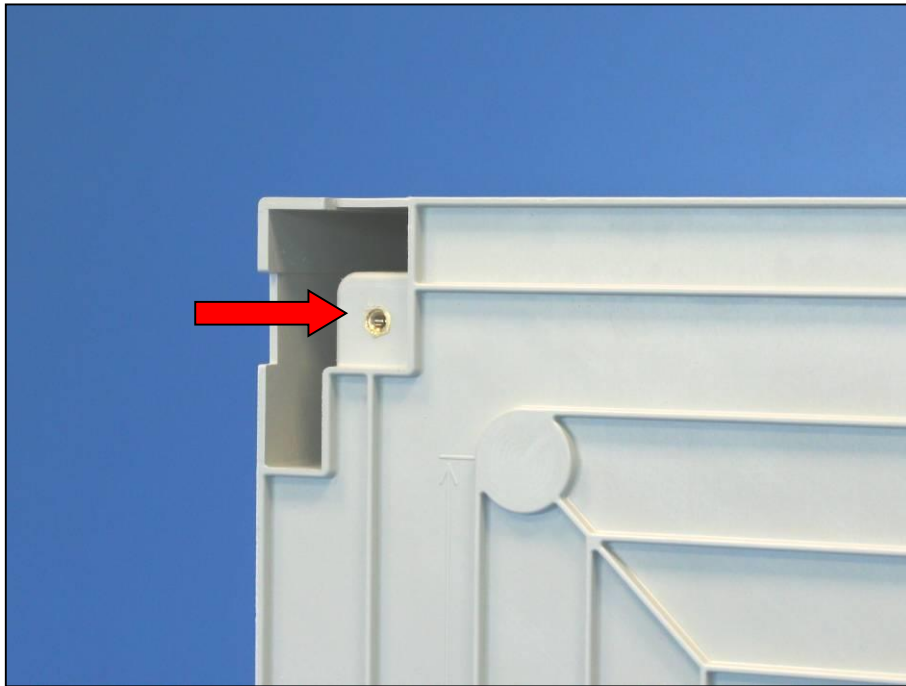

FIXING OF THE BOARDS

The brackets can be put horizontally or vertically according to the needs . The brackets hold the board perfectly flush-mounted.

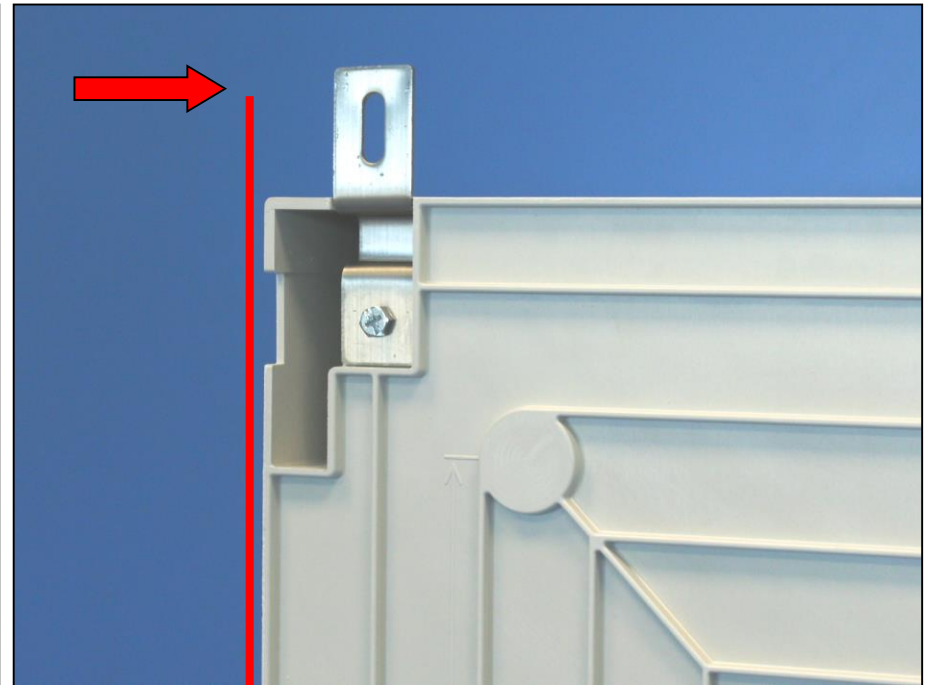
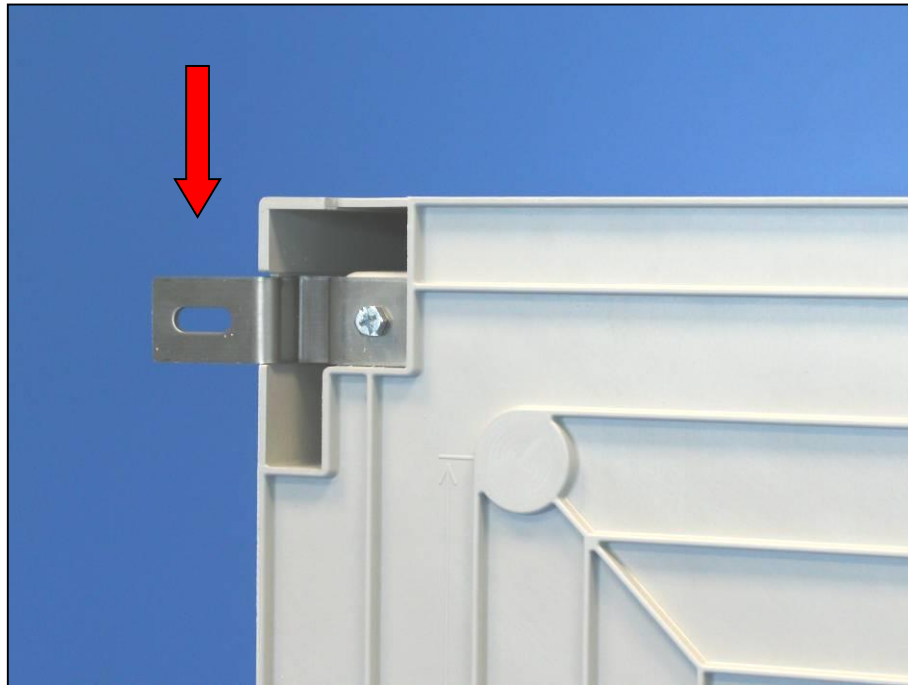

FIXING OF THE BOARDS

Through threaded rods M6 for the mounting on different supports (for instance pole)

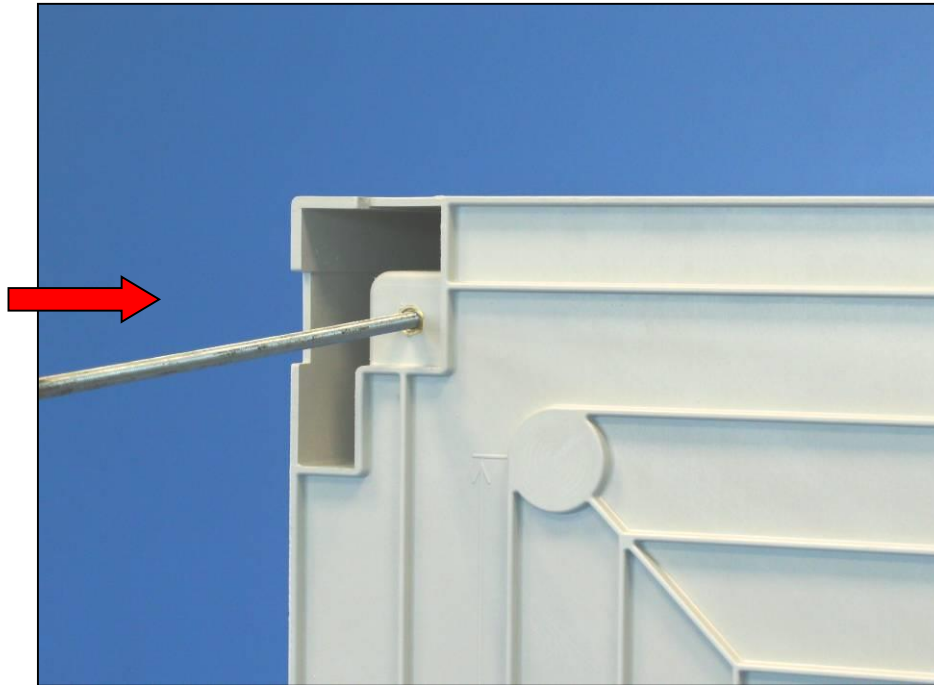

DOOR OPENING

The doors are available in two versions: blank or with window



DOOR OPENING

The door has an opening angle greater than 180° so that it remains against the wall and doesn't create any obstacle or danger.

The door has some seats for the fixing of cable tie supports or flexible slotted trunkings.

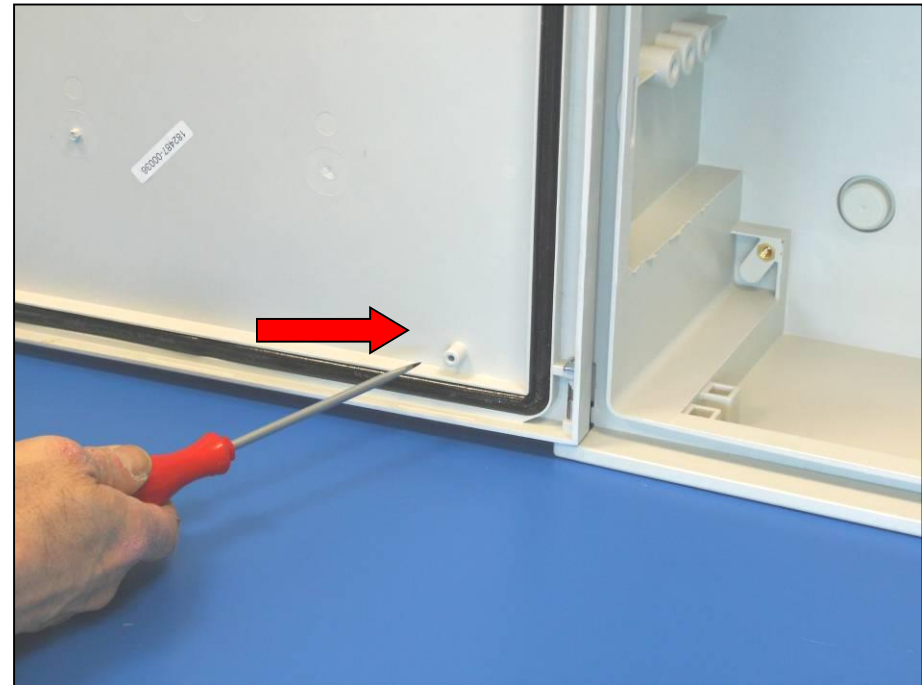

DOOR OPENING

The door is equipped with a standard lock with triangular key.
The standard lock can be replaced by a coded key.



DOOR OPENING 1

The door can be hinged with either left or right opening.
In order to change the opening release the stainless steel pin spring.

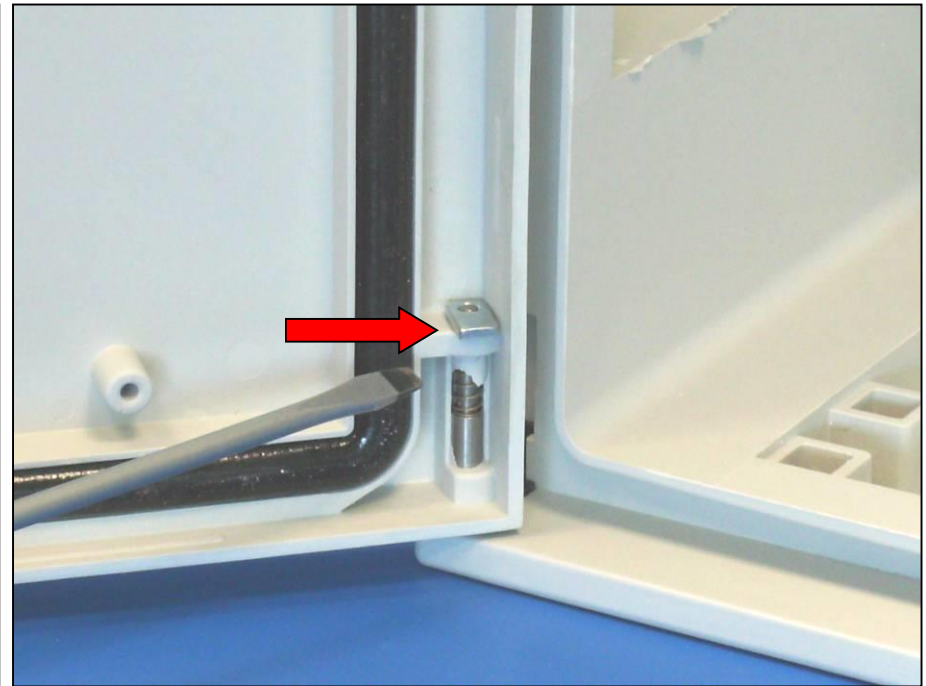
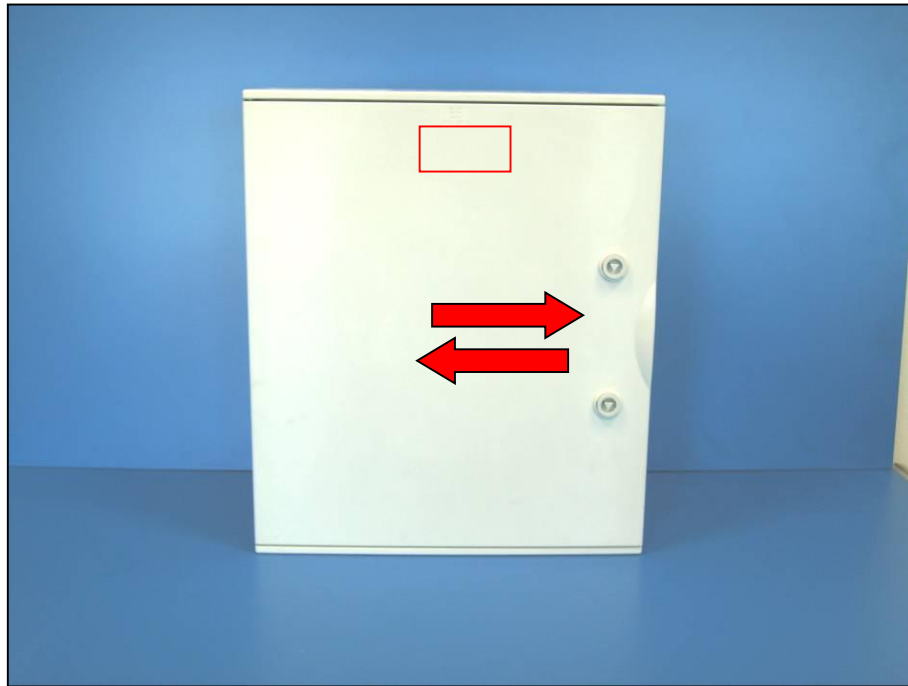

DOOR OPENING 2

Put the rotating plates again in their seats but in the opposite side of the board.

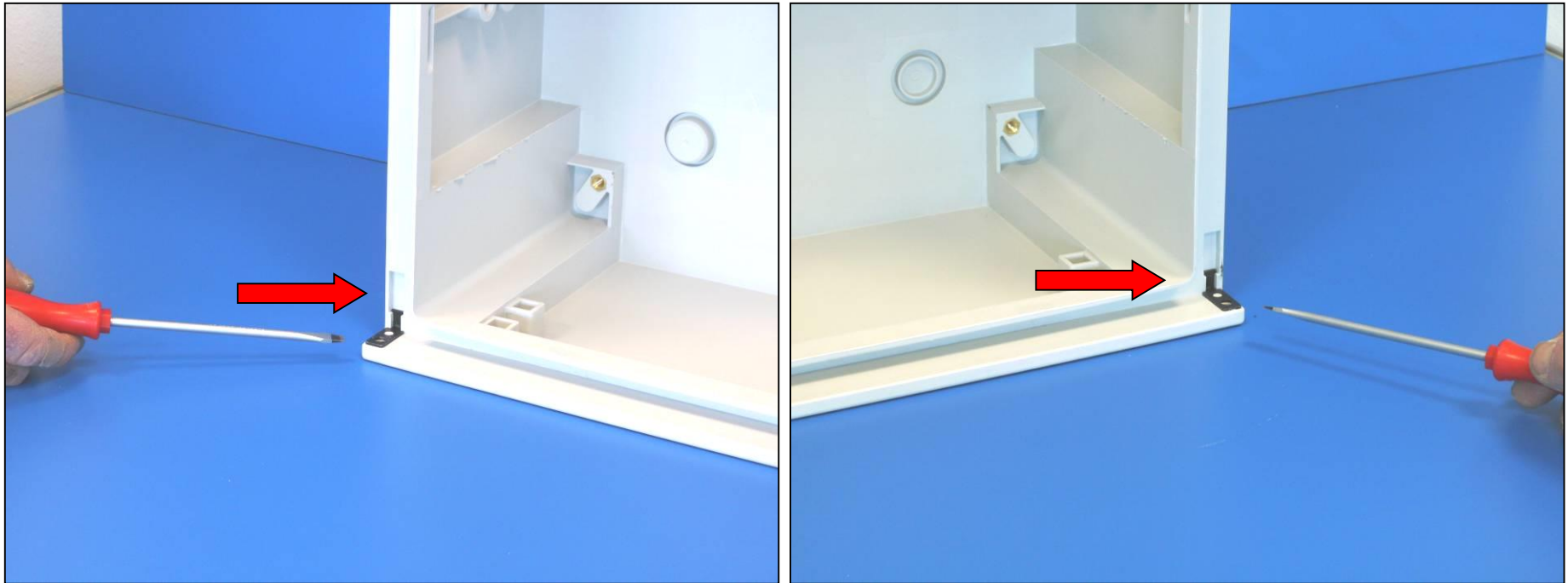

DOOR OPENING 3

Insert the fixed and movable pin to fix the door

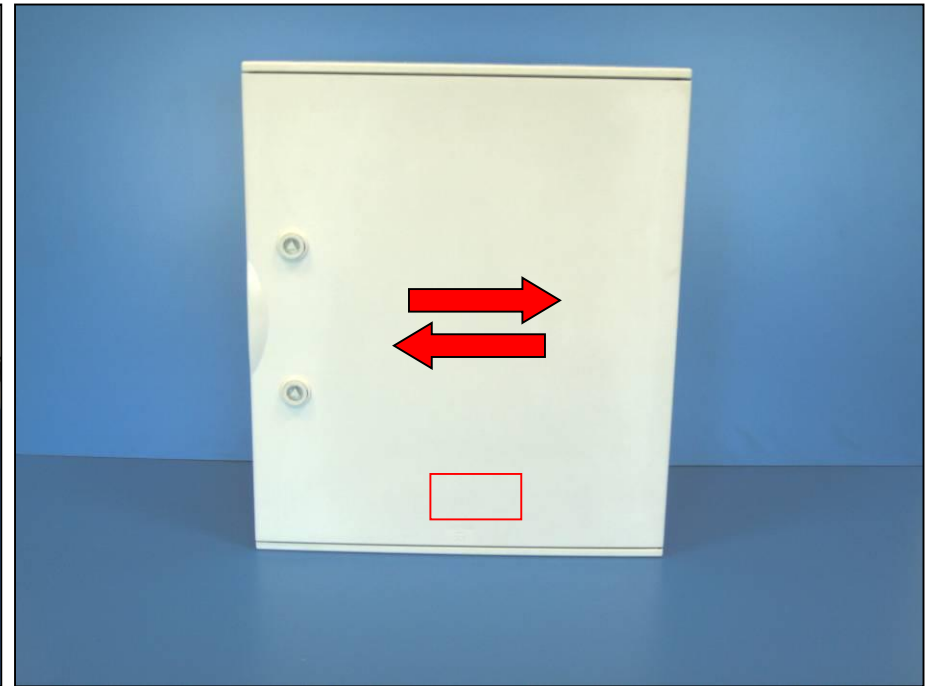
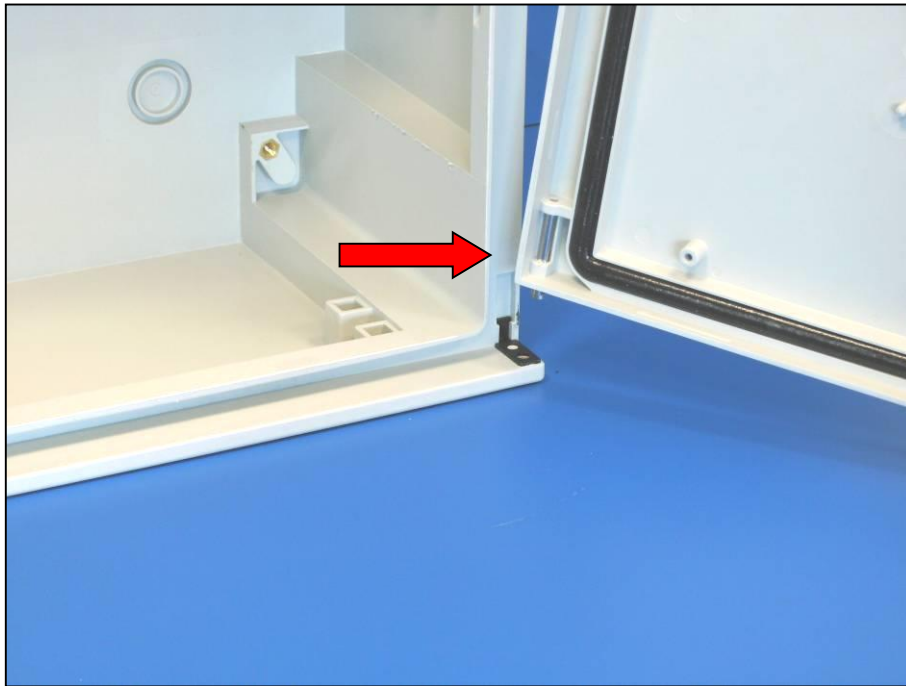

BACK PLATES

There are two types of back plates: metal or insulating



BACK PLATES

The back plates can be installed in the lowest part simply by fastening them to the fixed inserts through M6 screws.

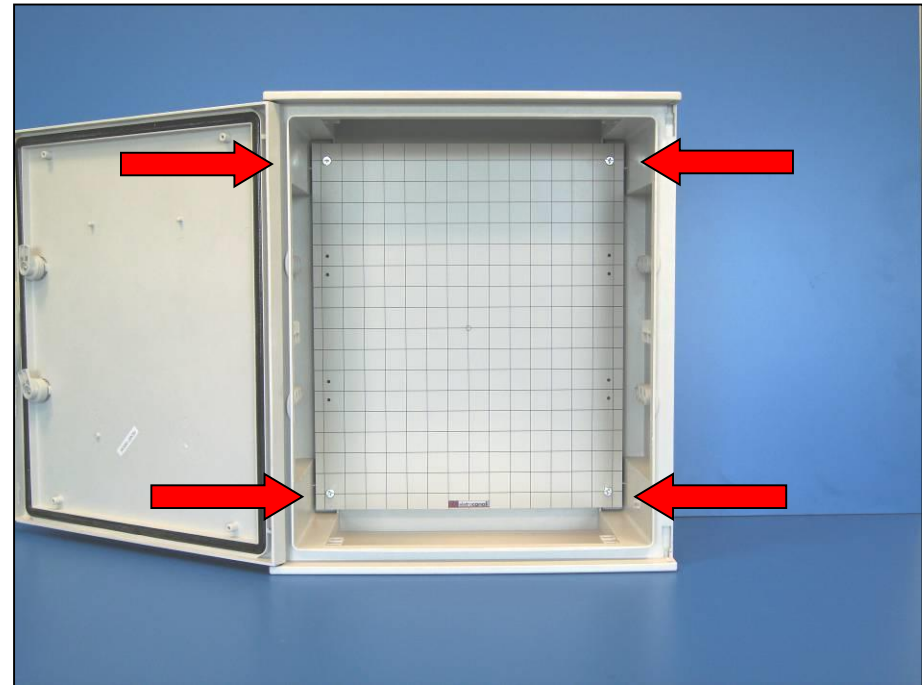

BACK PLATES

Back plates can be placed at different heights by the proper adjusting kit.

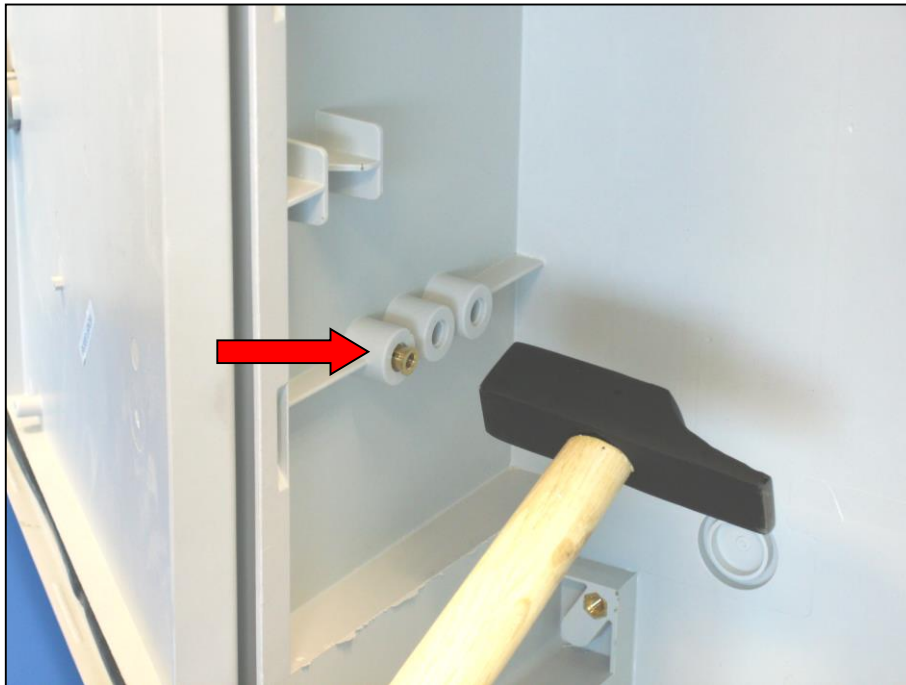

BACK PLATES

Back plates can be placed at different heights by the proper adjusting kit.

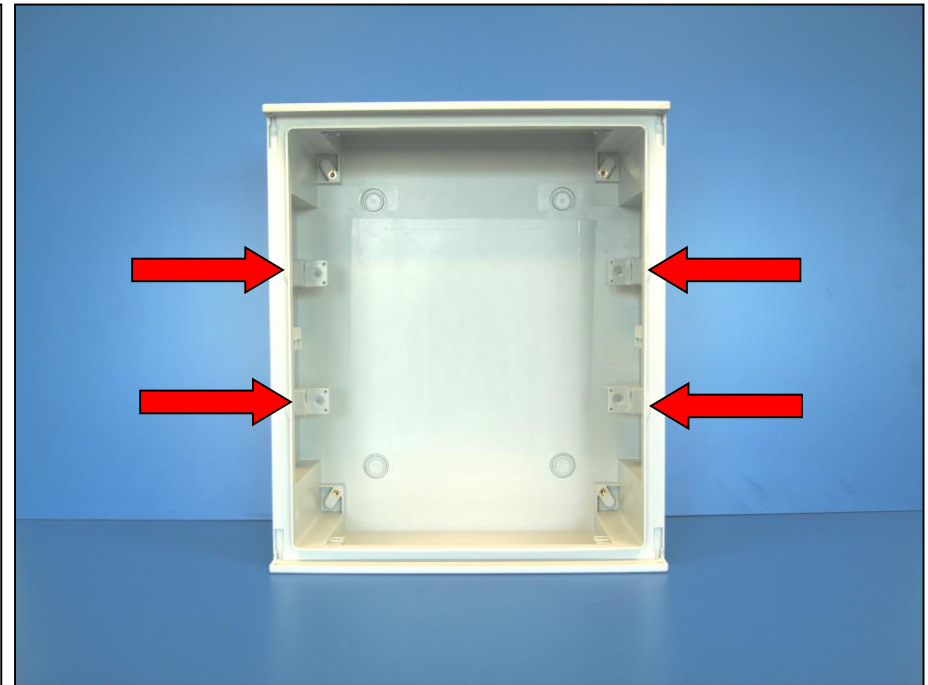
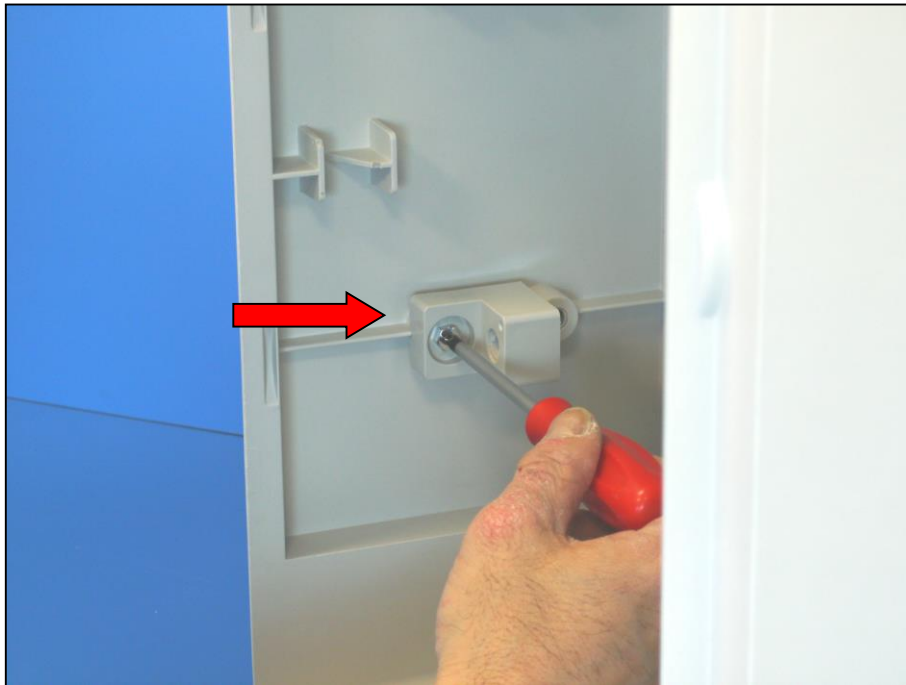

BACK PLATES

Back plates can be placed at different heights by the proper adjusting kit.

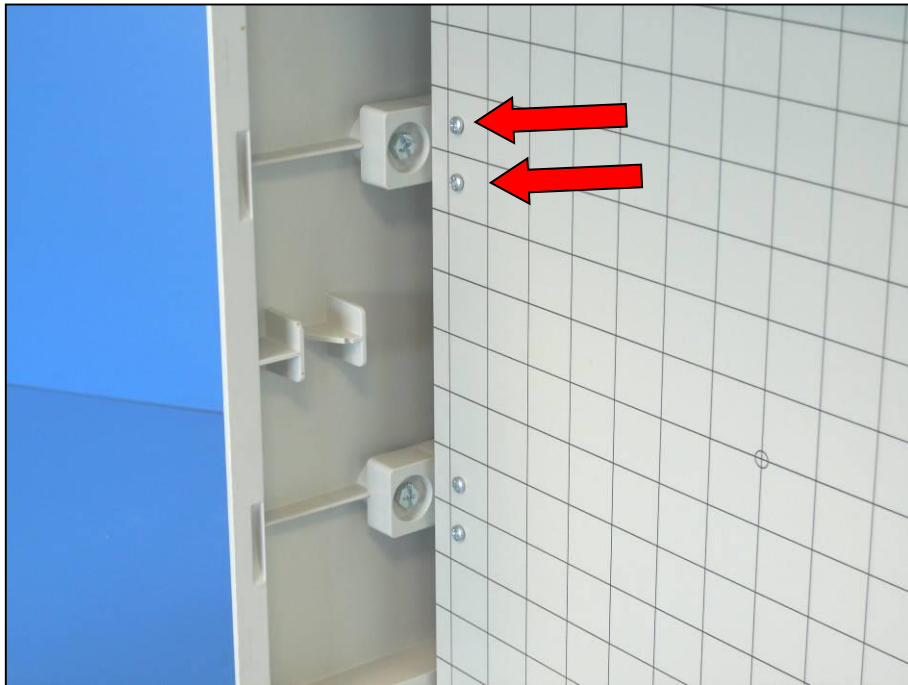

COUNTER-DOOR

The counter-doors are characterized by a rapid fixing through stainless steel spring pins.

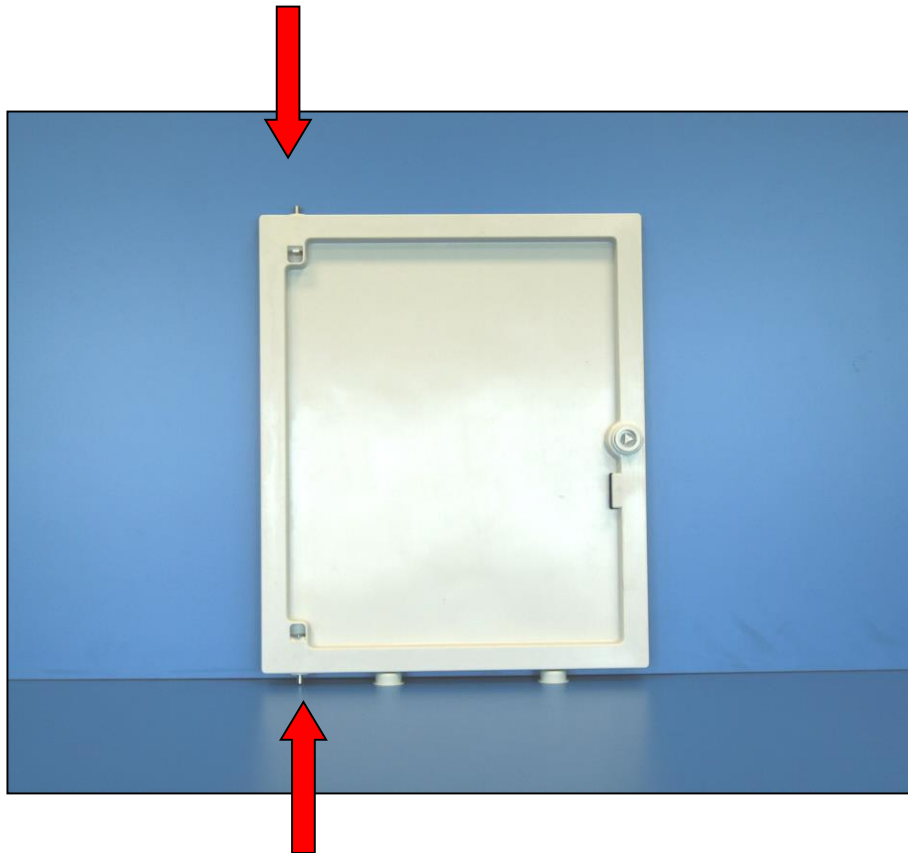

COUNTER-DOOR

The counter-doors are equipped with ergonomic handle and standard lock system with triangular key

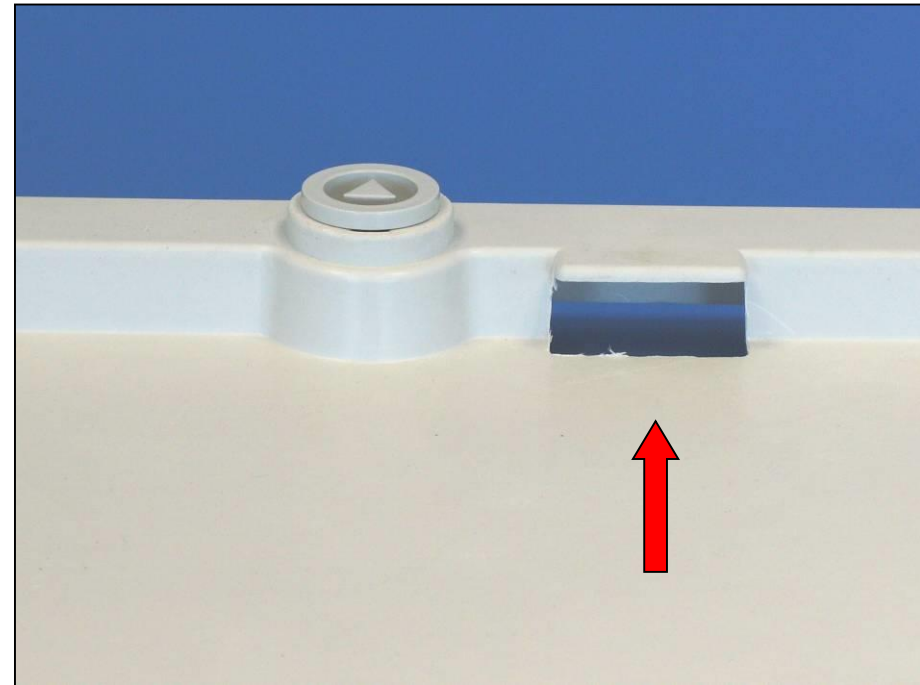
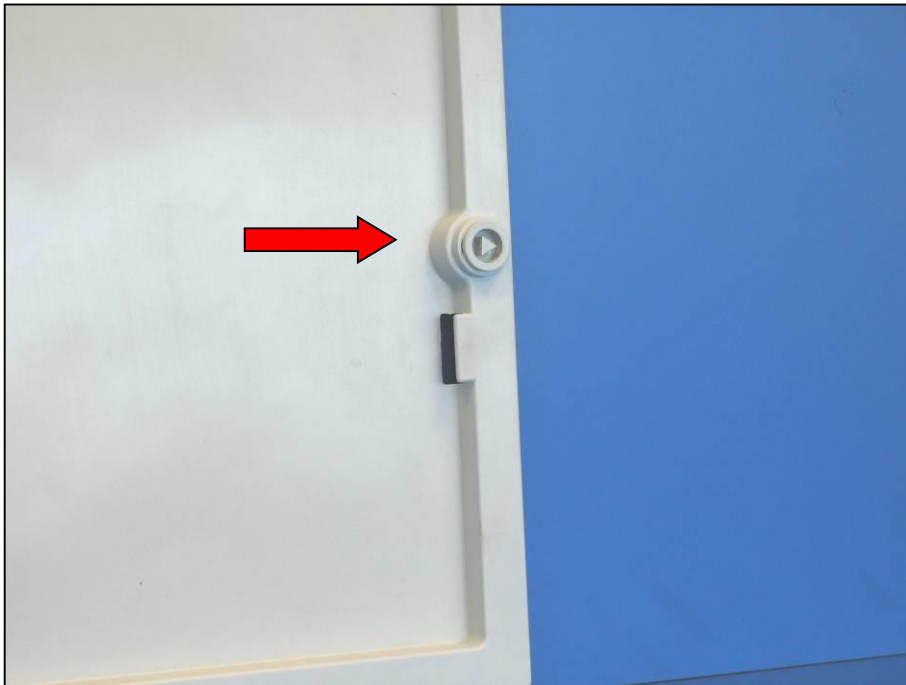

COUNTER-DOOR

The counter-doors are mounted on the bushings and the lock pins which must be set in their proper seats at the bottom of the board. (1)

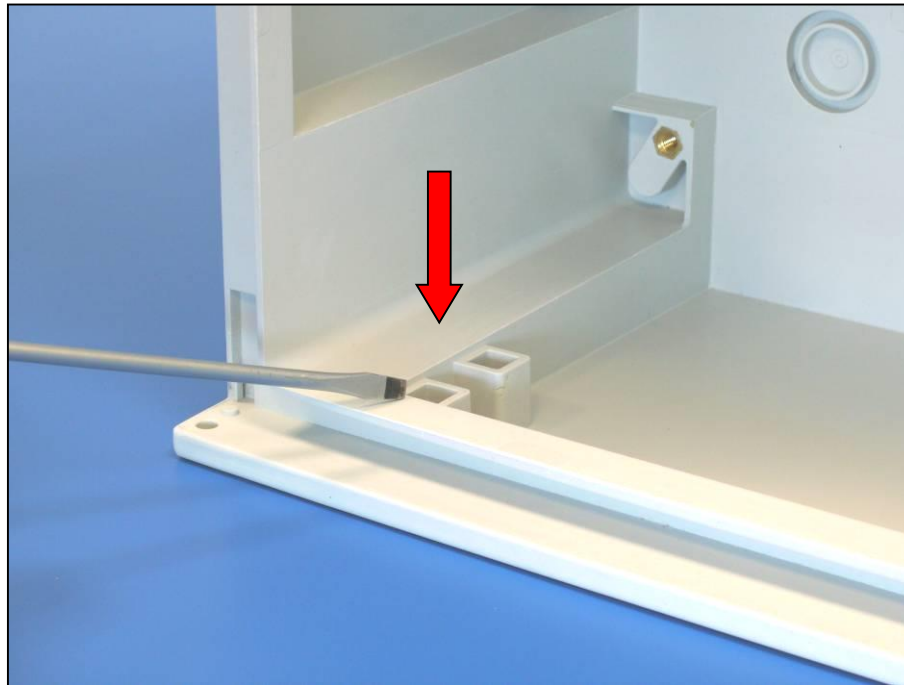

COUNTER-DOOR SYSTEM

The counter-doors are mounted on the bushings and the lock pins which must be set in their proper seats at the bottom of the board. (2)

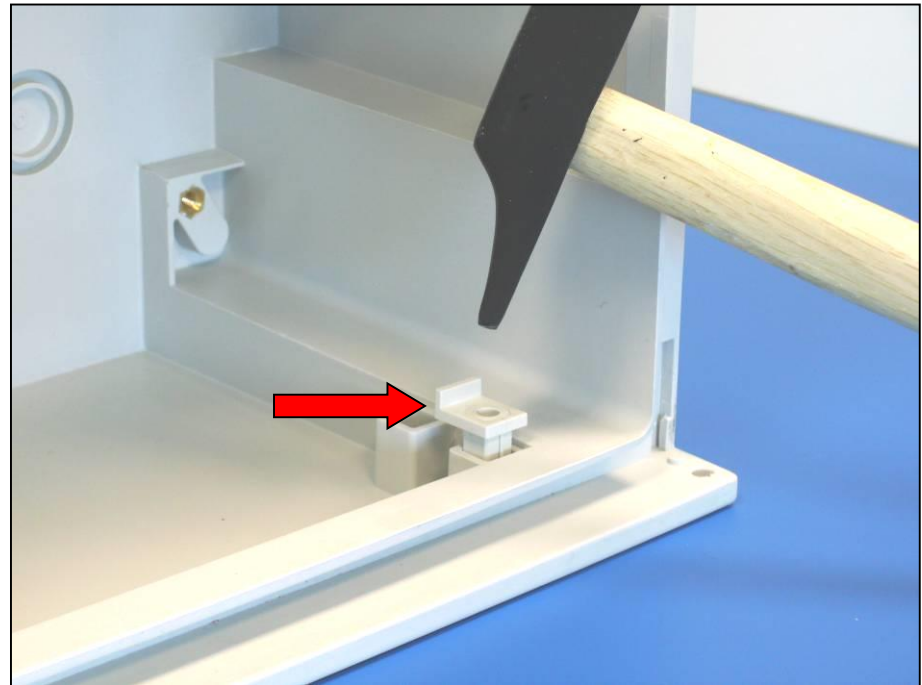
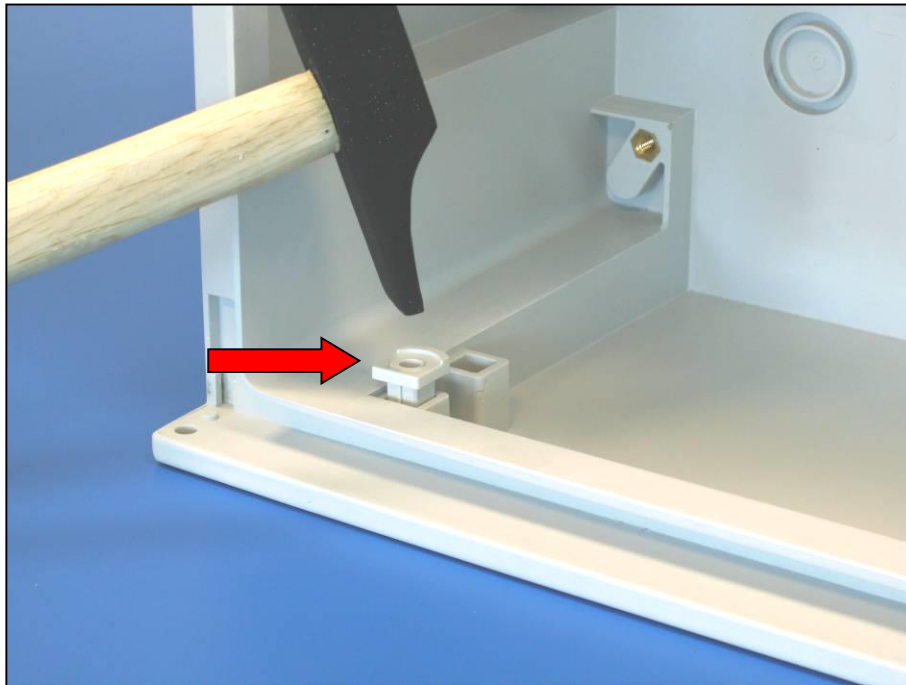

COUNTER-DOOR

The counter-doors are mounted on the bushings and the lock pins which must be set in their proper seats at the bottom of the board.(3)

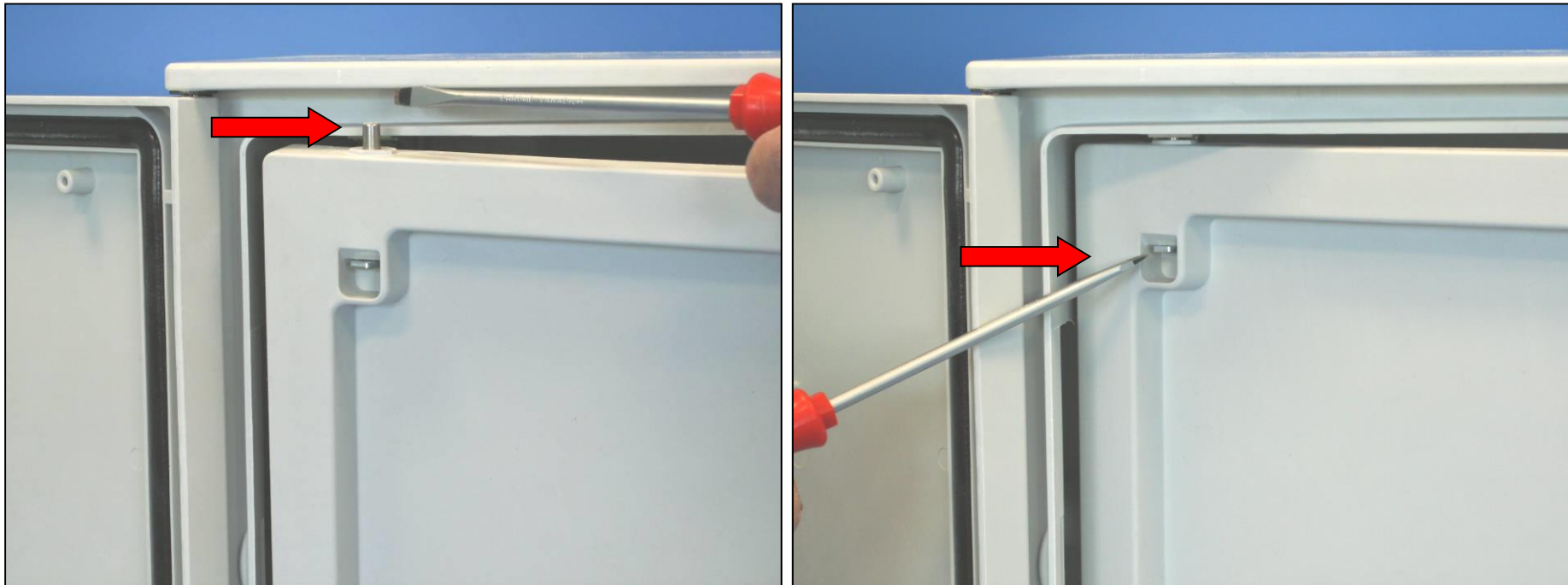

COUNTER-DOOR

The counter-door can be opened either left or right. In order to modify the opening exchange the bushing and the lock pin and turn the counter-door by 180°.

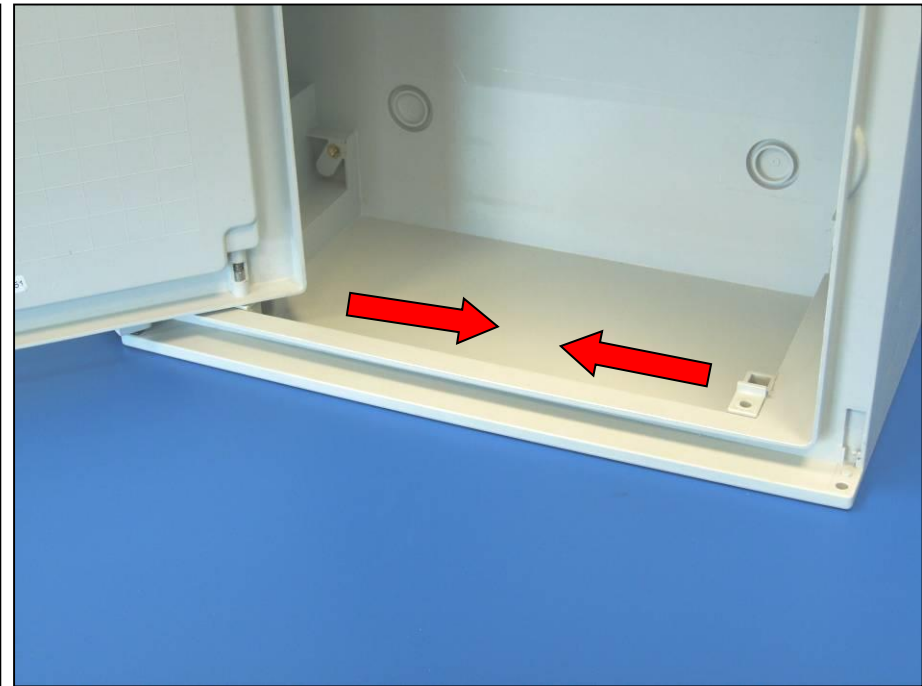
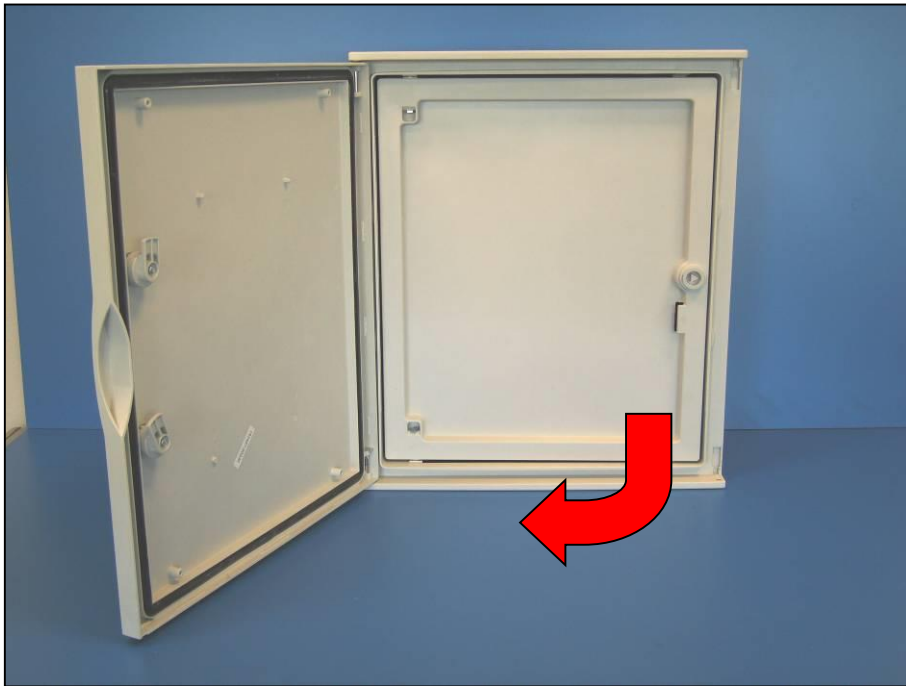

COUNTER-DOOR

The counter-doors are equipped with a reference grid for the fixing of the different devices.

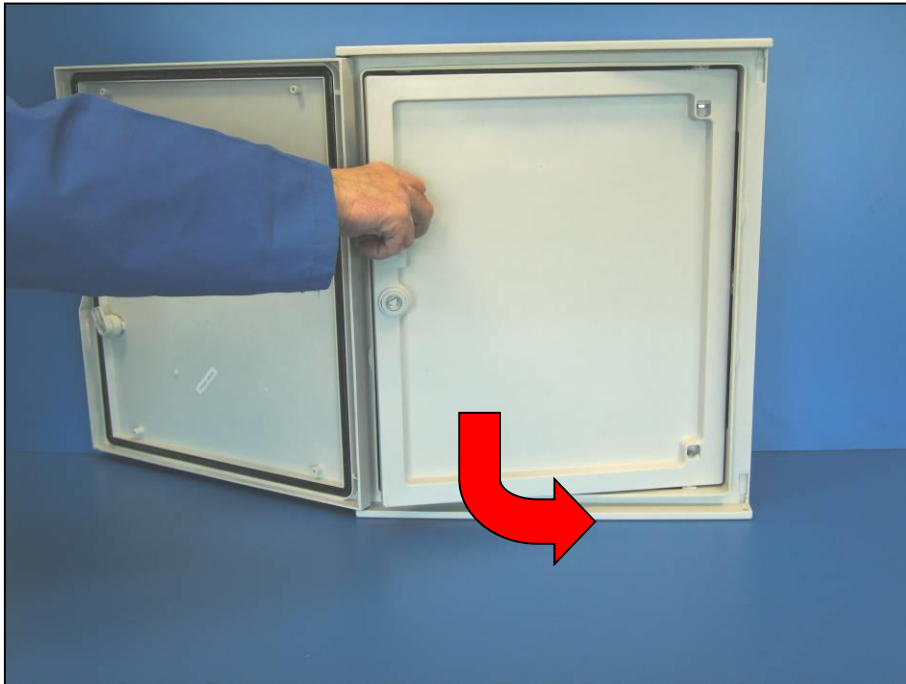

COUNTER-DOOR

The counter-doors can be installed at two different heights by adjusting the distance between the door and the counter-door between 43 and 73 mm in the blank version, -9 mm for the version with the window.

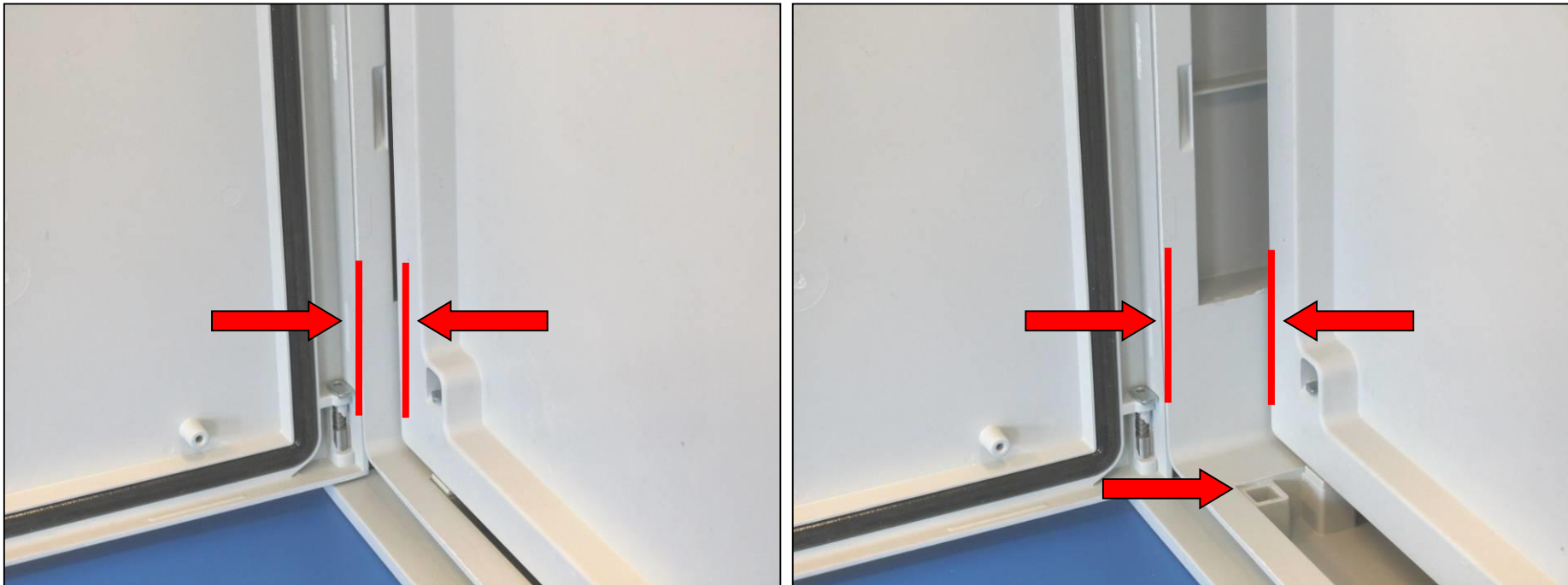

MODULAR FRAME

The modular frame is fixed to the board by setting the proper expansion inserts in the desired position.

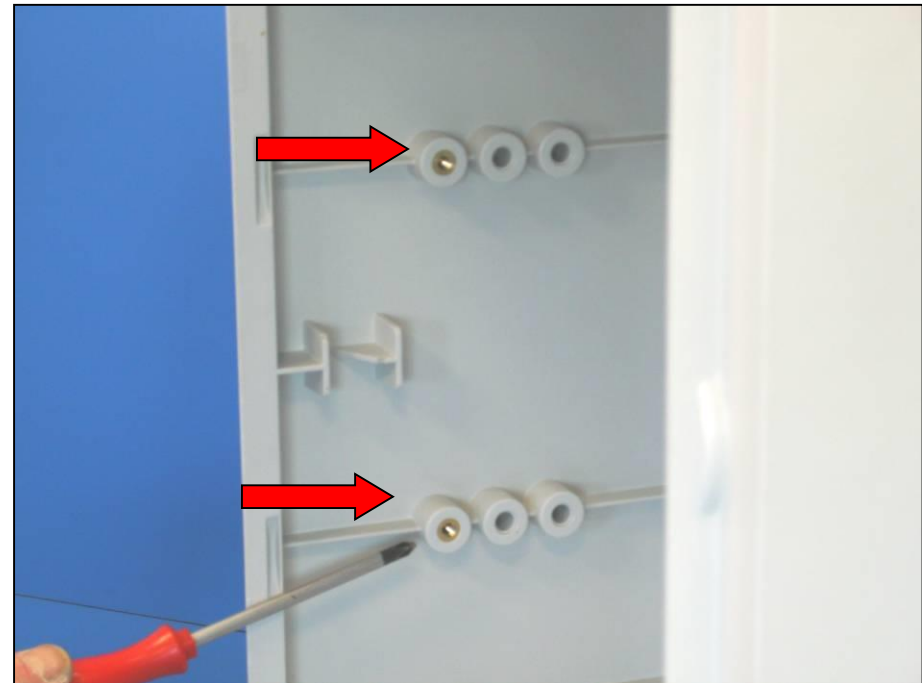
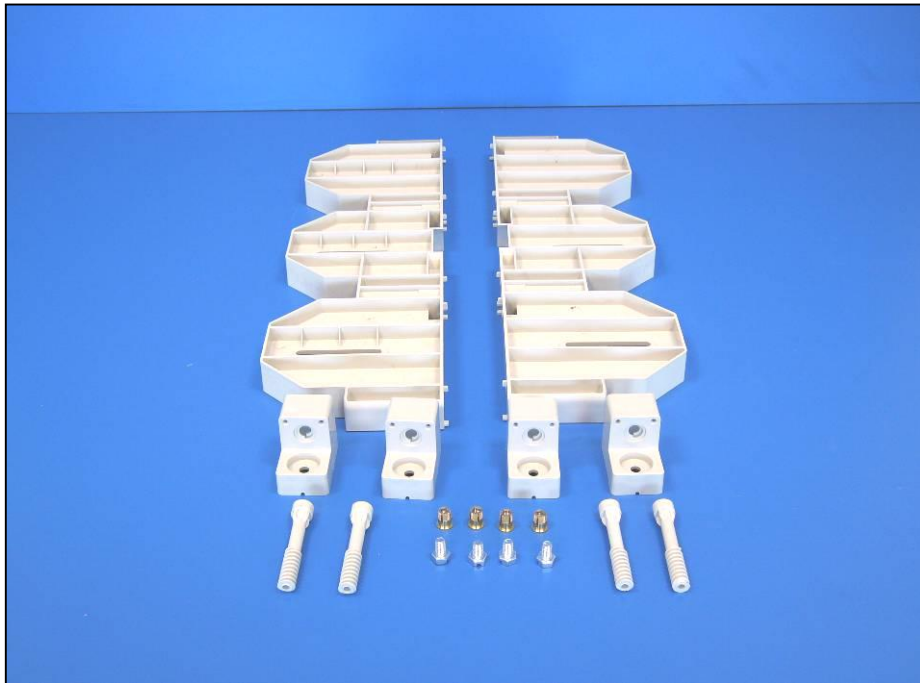

MODULAR FRAME

The modular frame is fixed to the board by setting the proper expansion inserts in the desired position.



MODULAR FRAME

The modular frame is fixed to the board by setting the proper expansion inserts in the desired position.

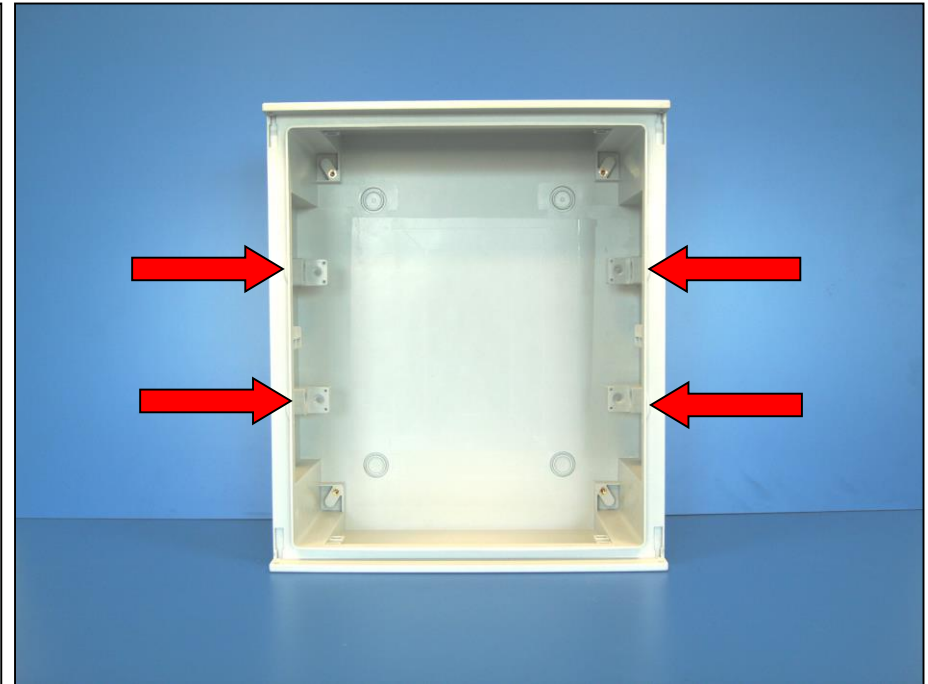
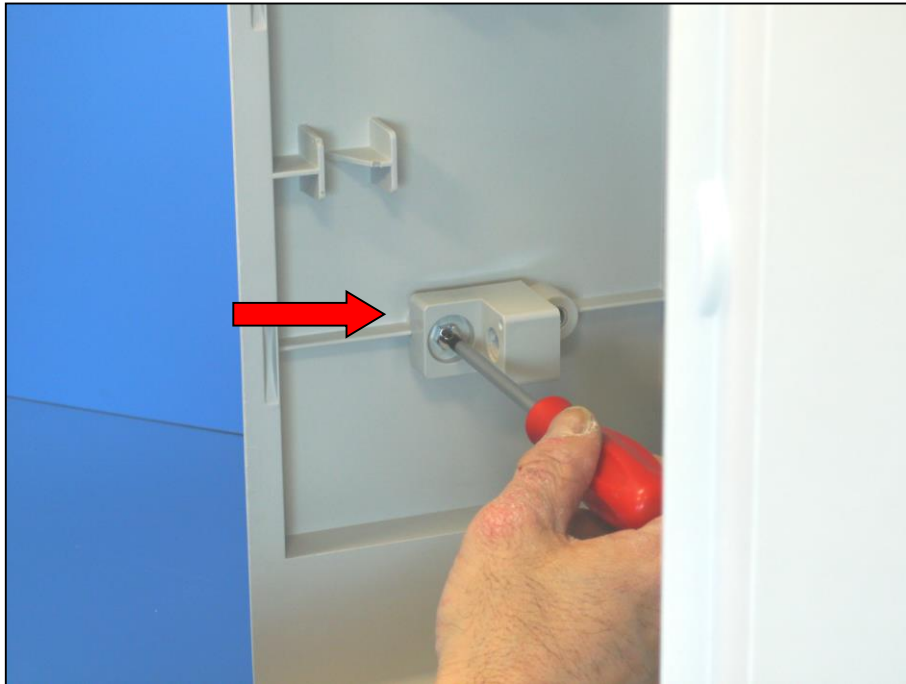

MODULAR FRAME

The modular frame is generally completed by the DIN rails and the related accessories

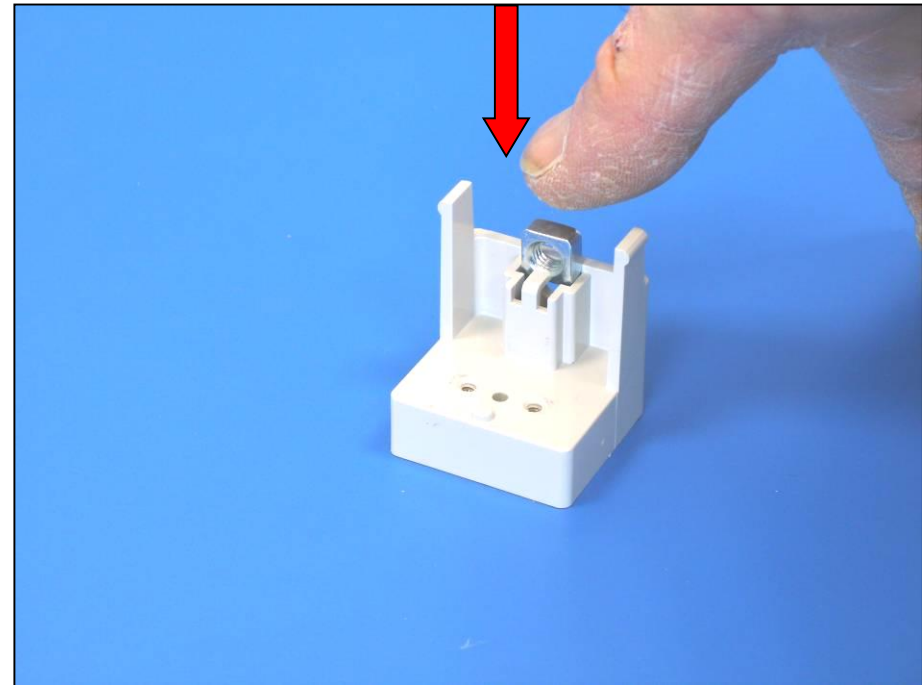
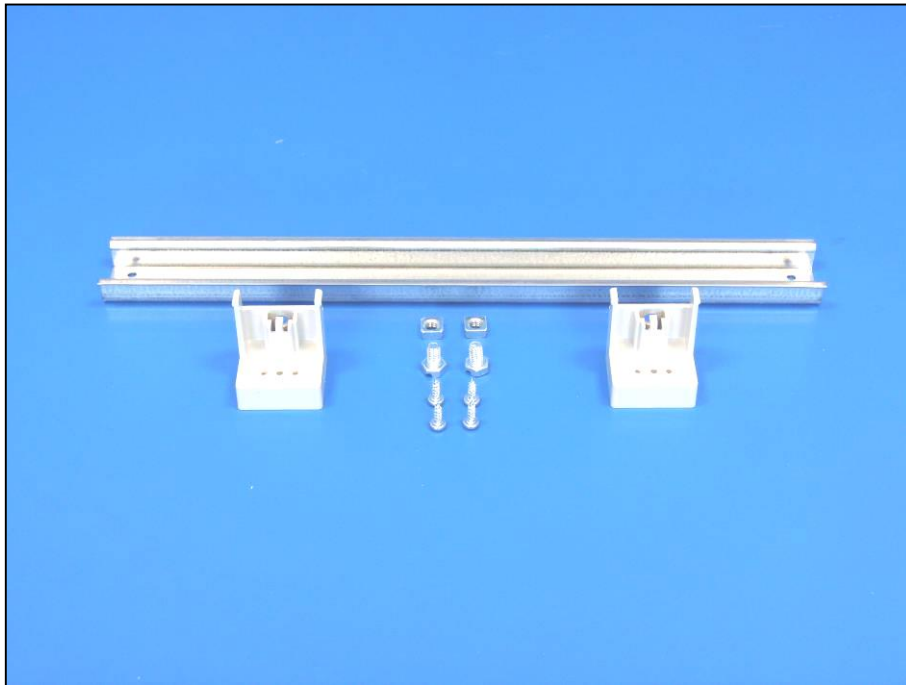

MODULAR FRAME

Mount DIN rails on their supports and put the square bolts in their seats..

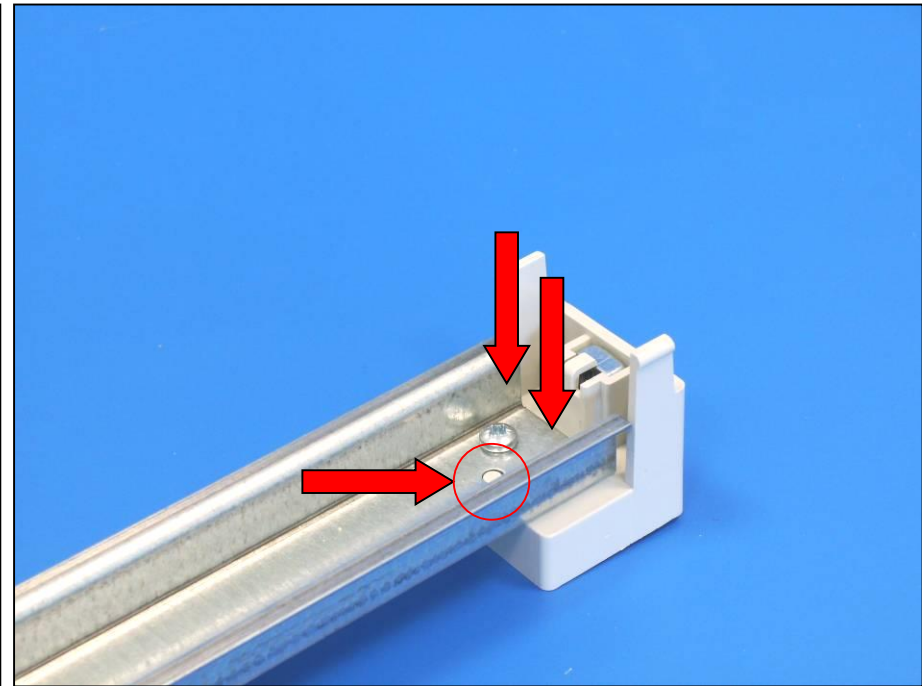
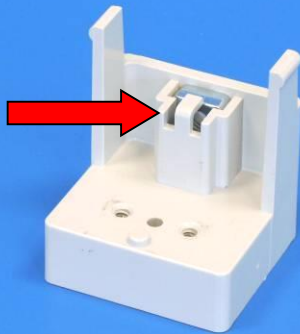

MODULAR FRAME

Mount the DIN rail and the support on the uprights at the desired height according to the installed devices, and fix everything by the proper screws.

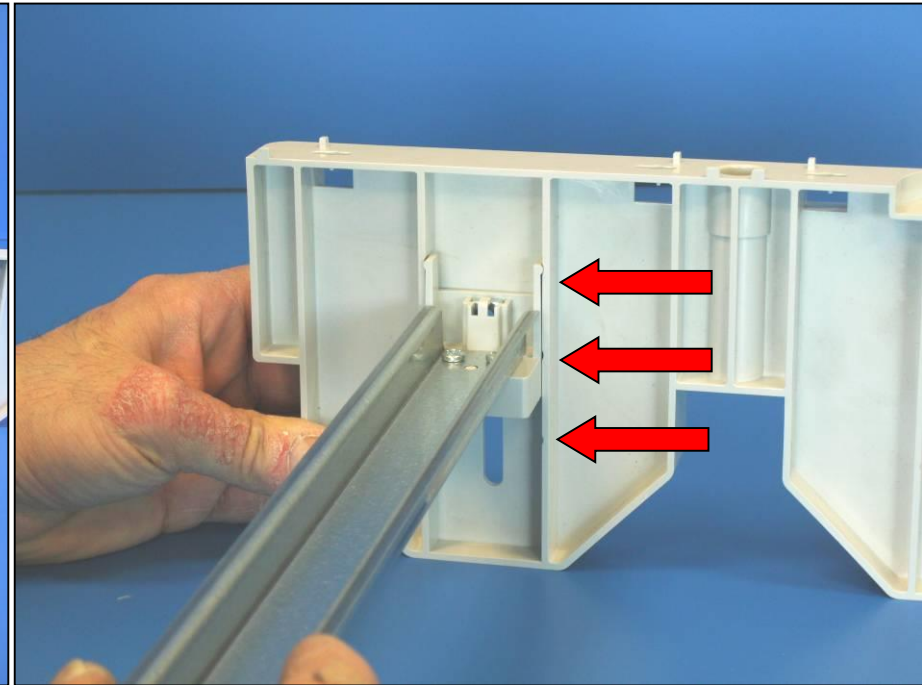
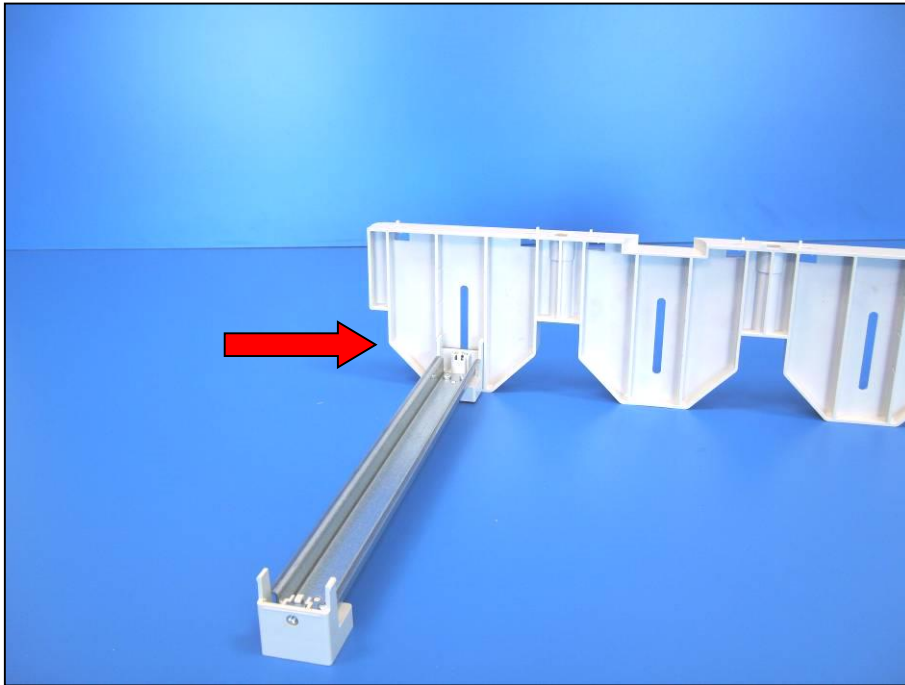

MODULAR FRAME

Wire the modular frame and put it into the board.

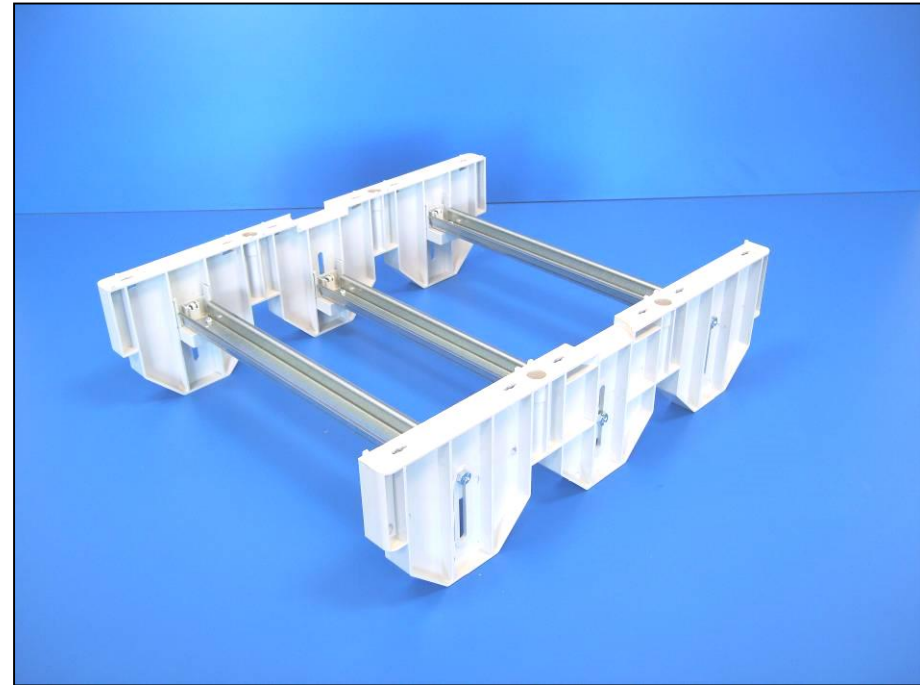
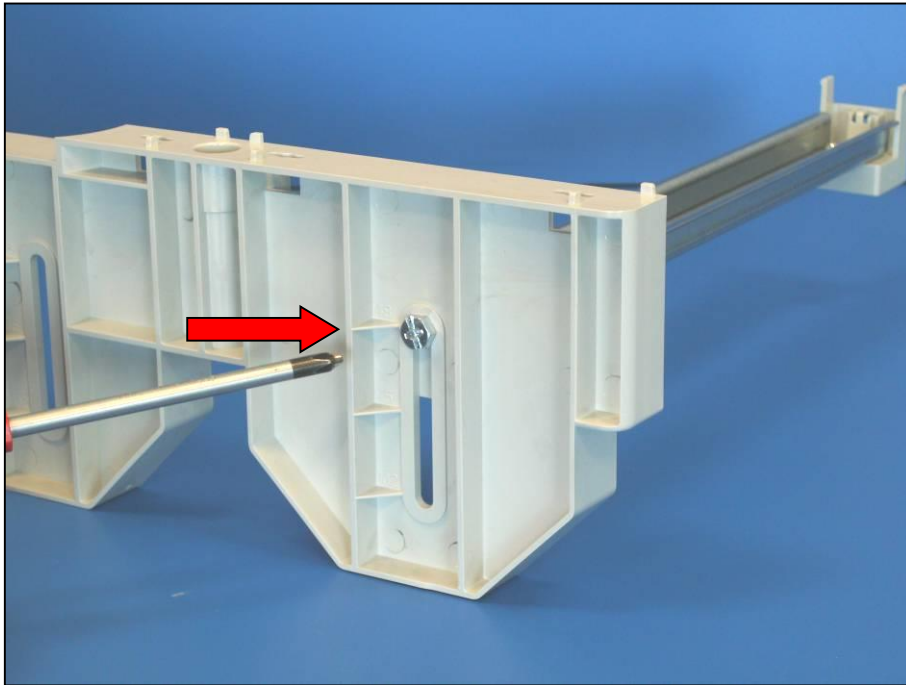

MODULAR FRAME

The frame is supported by the case and the installer can perform the wiring / maintenance with both hands free.

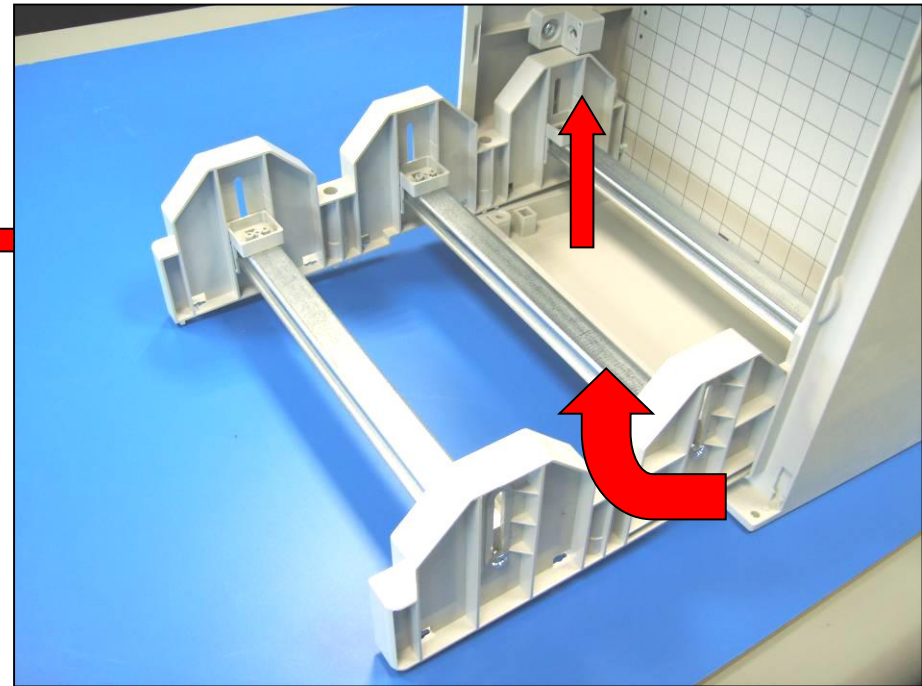
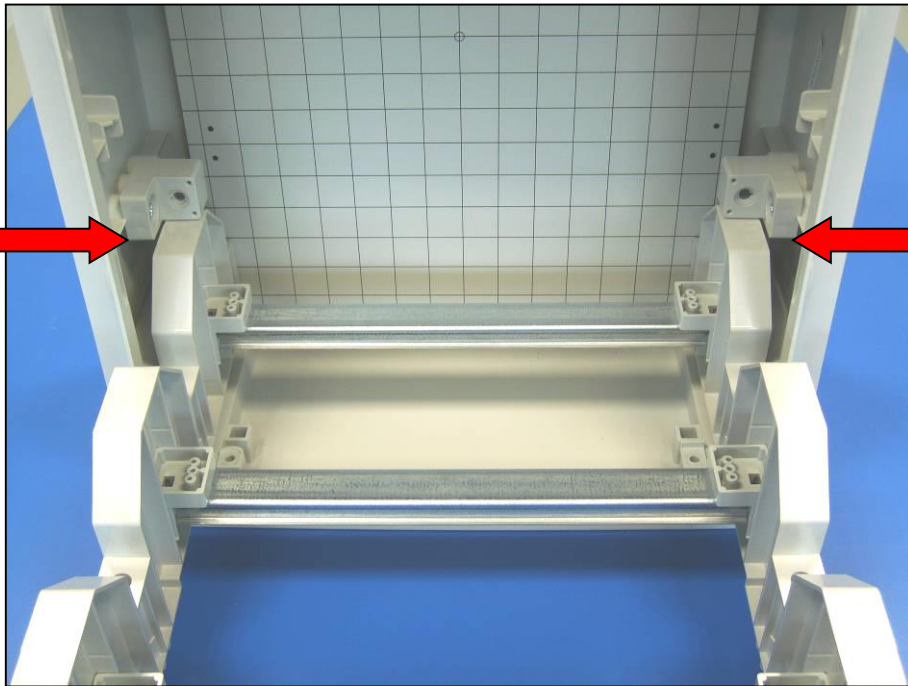

MODULAR FRAME

Secure the frame with the fast-pitch screws.

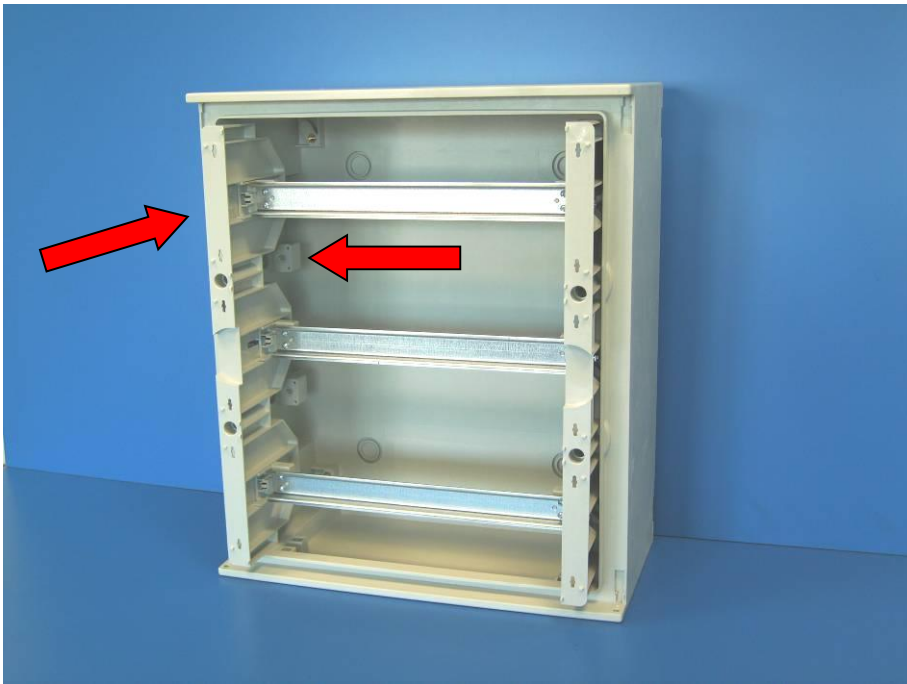

MODULAR FRAME

It is also possible to install 25-40mm high slotted trunkings behind the frame to make the wiring easier.

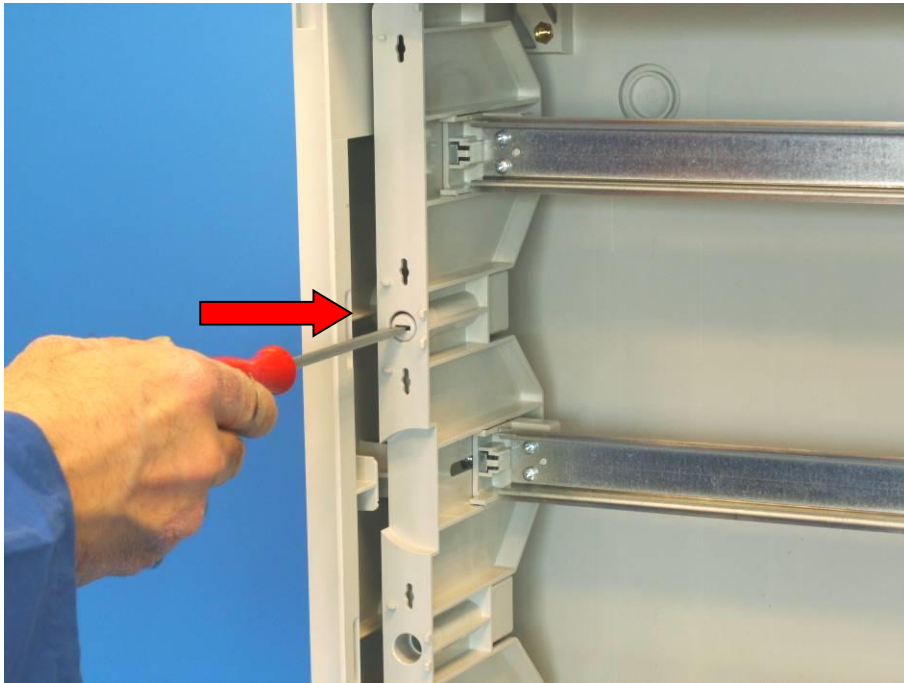

MODULAR FRAME

Complete the frame with one-row windowed or blank plates or....



MODULAR FRAME

...with two-row blank plates through $\frac{1}{4}$ turn fast screws.

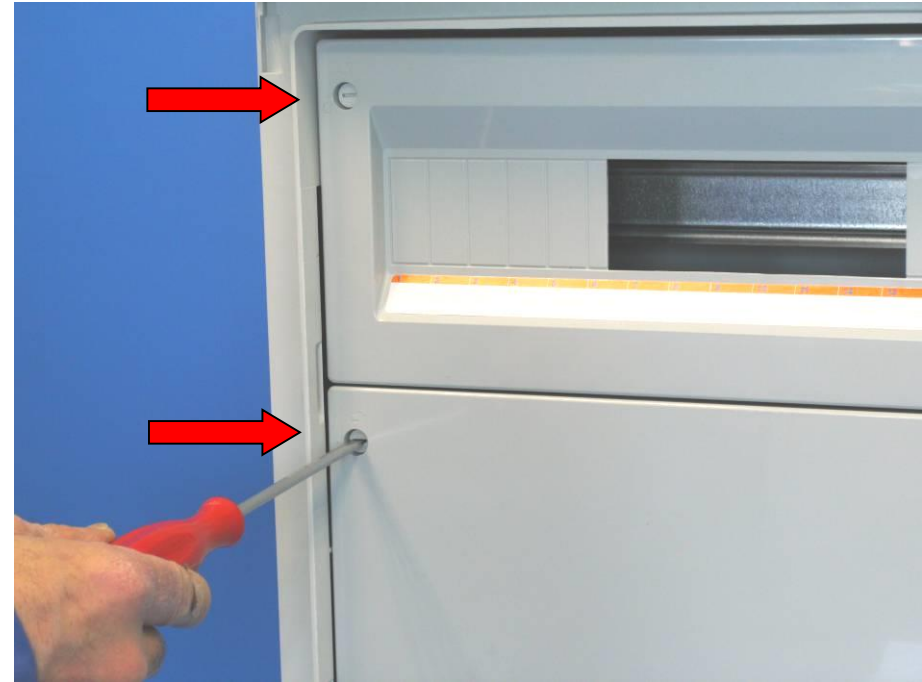

MODULAR FRAME

The frame installed in the highest position ensures the IP20 protection degree also with the open door.

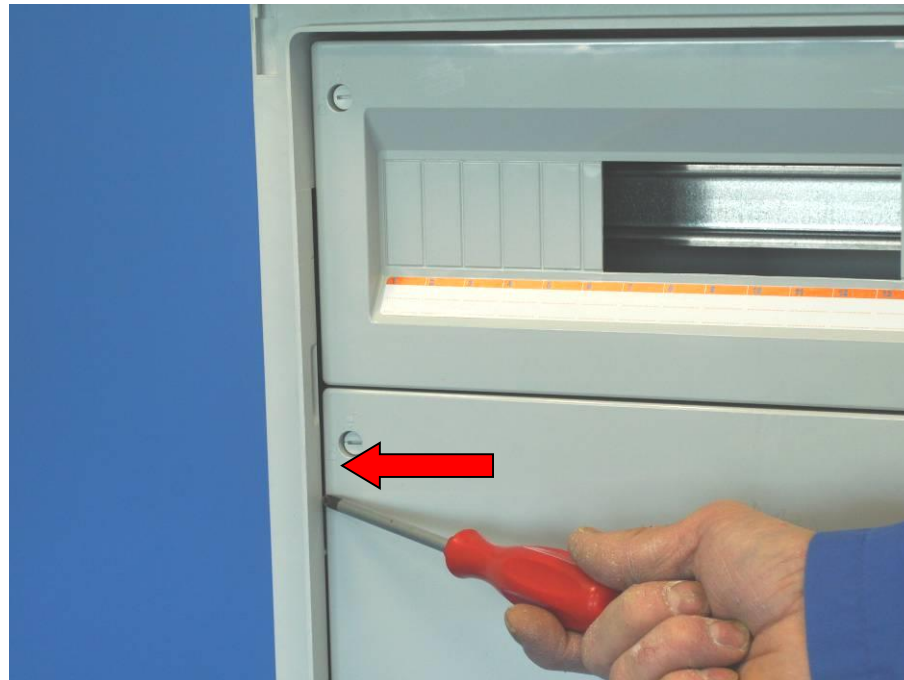

SPECIAL WIRINGS

It 's also possible to put the back plate in the lowest position, install the frame with the DIN rails in the highest position, the counter-door in the highest position



SPECIAL WIRINGS

In this way you can wire at the same time equipments fixed to the plate and other ones fixed to DIN rails, signallers and carry out operations on the counter-door.

The counter-door can't be rotated but can be easily pulled out as it is equipped with two independent spring pins.





electrical installation systems

Thanks for your attention